

emmegi®

ATTESA

emmegi®



attesa - waiting - attente - warten - espera

attesa - waiting - attente - warten - espera

## attesa

Si dice che l'attesa sia lunga, noiosa, ma può essere anche breve, piacevole, confortevole. Con la collezione Attesa non si parla solo di comodità, ma di ricerca e adattabilità, attraverso un'ampia scelta di forme, strutture, rivestimenti e cromie. La cura del progetto e la volontà di fondere le sedute all'ambiente circostante, rendono questa collezione adattabile ad un uso contract, destinata a spazi grandi, come le hall degli hotel o piccoli come le sale d'attesa.

Emmegi è un'azienda che oggi nel settore delle sedute per ufficio e per il contract è sinonimo di una qualità innovativa e funzionale e di una costante ricerca progettuale intesa come giusto equilibrio tra le esigenze del mercato e i dettami del gusto estetico. Emmegi è anche altro: consapevole, infatti, della necessità di adottare sistematicamente un comportamento sensibile alla salvaguardia e protezione dell'ambiente, ha riprogrammato l'intera attività aziendale in funzione di una riduzione dell'impatto ambientale e nel rispetto delle risorse, certificati UNI EN ISO 14001.

2 Waiting can be long and boring but it can also be short, pleasant and comfortable. Behind the Attesa collection there is not only comfort but also research and adaptability, thanks to a wide choice of shapes, structures, upholstery and colours. Meticulous design and a desire to make chairs fit into surroundings, make this collection adaptable for the Contract sector, for large spaces including hotel foyers or small ones such as waiting rooms. Today, as a company in the office and contract chair sector, Emmegi is synonymous with innovative and functional quality, as well as ongoing research into design as the right balance between market demands and the dictates of taste. Emmegi is also much more: aware of the need to systematically adopt an approach based on safeguarding and protecting the environment, the company has reorganised all its company activities to reduce environmental impact and respect resources, achieving UNI EN ISO 14001 certification.

L'attente est souvent longue et ennuyeuse, mais elle peut s'avérer courte, agréable et confortable. Avec la collection Attesa, on ne parle pas seulement de confort, mais aussi de recherche et d'adaptabilité grâce à un vaste choix de formes, de structures, de revêtements et de coloris. Le soin apporté au projet et la volonté de mêler les sièges au milieu environnant rendent cette collection adaptable à un usage Contract, pour les grands espaces comme le hall des hôtels ou ceux plus petits comme les salles d'attente. Emmegi est aujourd'hui synonyme de qualité innovatrice et fonctionnelle et de recherche conceptuelle constante, vue comme un juste équilibre entre les exigences du marché et les règles de nature esthétique, dans le secteur des sièges pour le bureau et le contract. Elle est bien plus encore : consciente de la nécessité d'adopter systématiquement un comportement sensible à la sauvegarde et à la protection de l'environnement, Emmegi a revu toute l'activité de l'entreprise dans l'optique de réduire l'impact sur l'environnement et de respecter les ressources, en obtenant la certification UNI EN ISO 14001.

Es wird behauptet, dass Warten lange dauert und langweilig ist, aber es kann auch kurz, angenehm, bequem sein. Mit der Kollektion Attesa ist damit nicht nur Bequemlichkeit gemeint, sondern Forschung und Anpassungsfähigkeit, durch eine große Auswahl an Formen, Strukturen, Bezügen und Farbvarianten. Die Sorgfalt der Projektentwicklung und der Wunsch, die Stühle mit der Umgebung zu verschmelzen, passen diese Kollektion für eine Contract-Verwendung an, die für große Räume wie Hotelhallen oder kleine Räume wie Wartezimmer bestimmt sind. Emmegi ist ein Unternehmen, das heute im Bereich der Stühle für Büros und Contract ein Synonym für innovative und zweckmäßige Qualität und eine konstante Projektforschung darstellt, was als das richtige Gleichgewicht zwischen den Marktanforderungen und dem ästhetischen Geschmack zu verstehen ist. Emmegi ist auch etwas Anderes: Das Unternehmen ist sich bewusst darüber, dass es notwendig ist, systematisch ein sensibles Verhalten für die Schonung und den Schutz der Umwelt anzunehmen, und hat die gesamte Aktivität des Unternehmens für eine Reduzierung der Auswirkung auf die Umwelt und mit Rücksicht auf die Ressourcen neu entworfen, was durch die Zertifizierung UNI EN ISO 14001 bestätigt wird.

Se dice que la espera es larga, aburrida, pero también puede ser breve, agradable y confortable. Con la colección Attesa no se habla sólo de comodidad, sino de investigación y adaptabilidad, a través de una amplia selección de formas, estructuras, revestimientos y tonalidades. El cuidado del proyecto y la voluntad de fusionar los asientos con el ambiente que los rodea, hacen que esta colección sea adaptable a un uso Contract, destinada a espacios grandes, como los vestíbulos de los hoteles o pequeños como las salas de espera. Emmegi es una empresa que hoy, en el sector de los asientos para oficinas y para el contract, es sinónimo de una calidad innovadora y funcional y de una constante investigación de planeamiento, entendida como equilibrio justo entre las exigencias del mercado y los dictámenes del gusto estético. Emmegi también es otras cosas: consciente, en efecto, de la necesidad de adoptar sistemáticamente un comportamiento sensible al resguardo y a la protección del medio ambiente, ha reprogramado la totalidad de su actividad empresarial en base a una reducción del impacto ambiental y reputando los recursos, certificados UNI EN ISO 14001.



domino

sistema modulare  
modular system  
système modulaire  
modulares System  
sistema modular

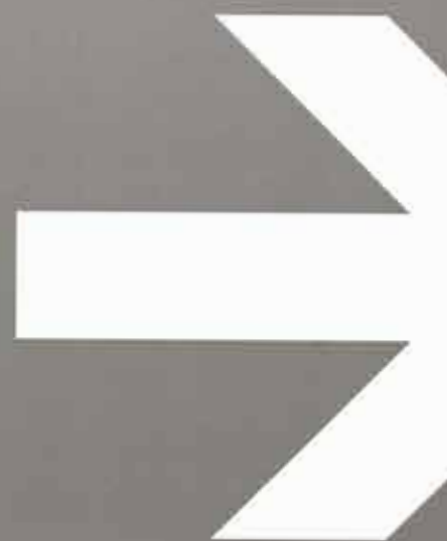

**domino**

sofà a due  
e tre posti

2/3-seater sofa

sofa à deux et  
trois places

Sofa mit zwei  
oder drei  
Sitzplätzen

Sofá de dos y  
tres cuerpos





**domino**

poltrona singola  
single chair  
fauteuil individuel  
Einzelner Sessel  
sillón individual

**milo**

sofà due posti  
2-seater sofa  
sofa à deux places  
Sofa mit zwei Sitzplätzen  
sofá de dos cuerpos





**park**

poltrona singola  
single chair  
fauteuil individuel  
Einzelner Sessel  
sillón individual



**park**

poltrona singola  
single chair  
fauteuil individuel  
Einzelner Sessel  
sillón individual

sofà tre posti  
3-seater sofa  
sofa à trois places  
Sofa mit drei Sitzplätzen  
sofá de tres cuerpos





**elis**

poltronicina singola  
single chair  
fauteuil individuel  
Einzelner Sessel  
sillón individual

**elis**

poltroncina singola  
single chair  
fauteuil individuel  
Einzelner Sessel  
sillón individual

sofà due posti  
2-seater sofa  
sofa à deux places  
Sofa mit zwei Sitzplätzen  
sofá de dos cuerpos

tavolino attesa  
waiting area table  
petite table d'attente  
Tisch für Wartebereiche  
mesita de espera



**business class**

poltrona singola  
single chair  
fauteuil individuel  
Einzelner Sessel  
sillón individual



**sulu**

panca con tavolino  
bench seat with table  
banc avec petite table  
Bank mit Tisch  
banco con mesita

panca tre posti  
banc trois places  
banc trois places  
Dreisitzer-Bank  
banco de tres plazas



kone

panca  
bench  
banc  
bank  
banco



10  
04  
88  
756  
356  
720  
796  
814  
927  
728  
266  
3208  
0188

WARSCHAU  
BERLIN-TEGEL  
OSLO  
STUTTGART  
PEKING  
**FUTURE**  
BASEL  
SAN FRANCISCO  
SHANGHAI PU  
SALZBURG  
PERM-N. NOV  
MOSKAU-DOM  
AND-LI

**joint**

- divano modulare
- Modular sofa
- canapé modulaire
- Modulares Sofa
- sofá modular

kea

poltrona singola  
single chair  
fauteuil individuel  
Einzelner Sessel  
sillón individual

sofà due posti  
2-seater sofa  
sofa à deux places  
Sofa mit zwei Sitzplätzen  
sofà de dos cuerpos

sofà tre posti  
3-seater sofa  
sofa à trois places  
Sofa mit drei Sitzplätzen  
sofà de tres cuerpos



**skyline**

poltrona girevole  
swivel chair  
fauteuil pivotant  
Drehsessel  
sillón giratorio

divanetto due posti  
2-seater couch  
canapé deux places  
Sofa mit zwei Sitzplätzen  
pequeño sofá de dos  
cuerpos





**skyline**

poltrona girevole  
swivel chair  
fauteuil pivotant  
Drehsessel  
sillón giratorio

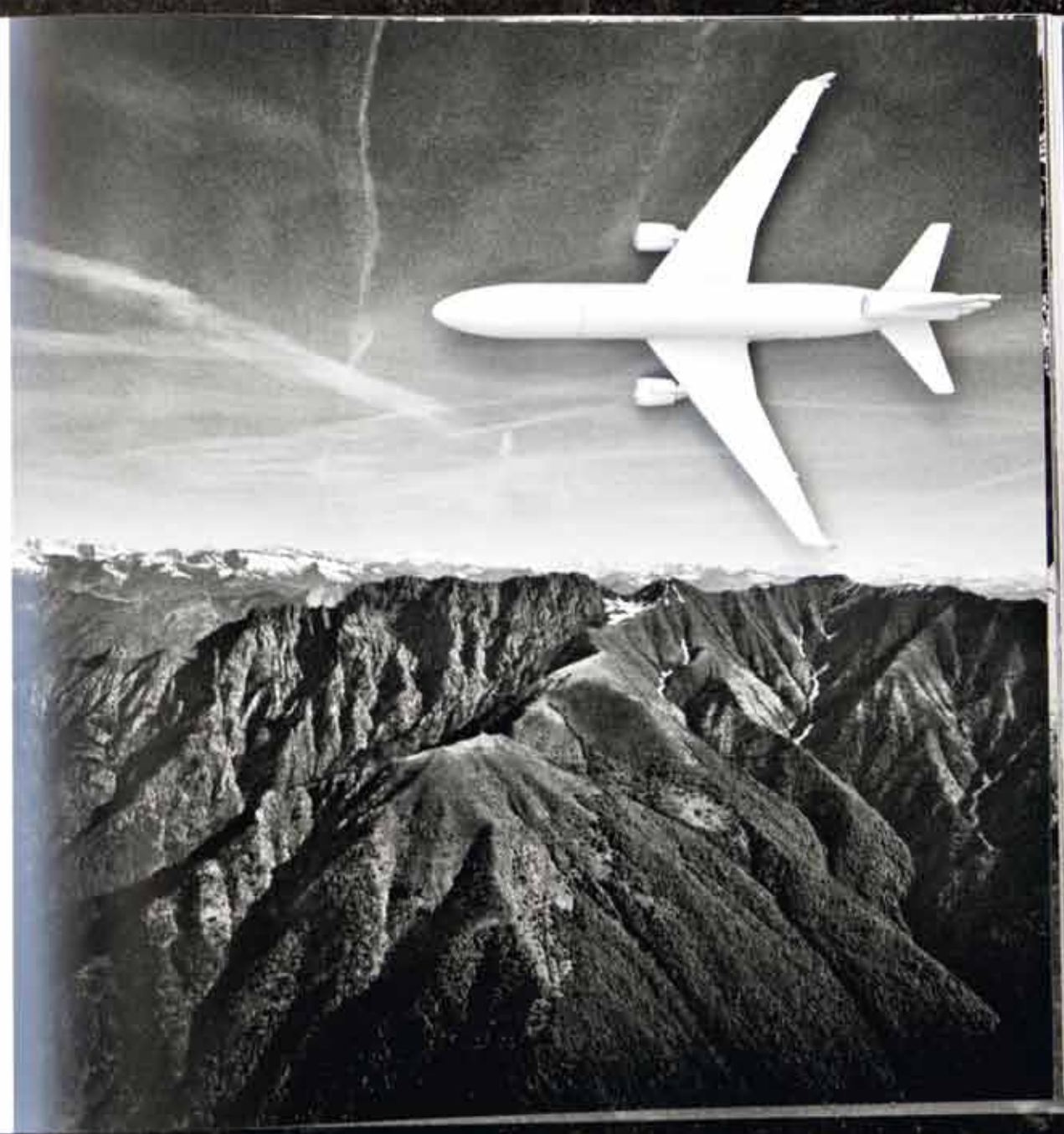
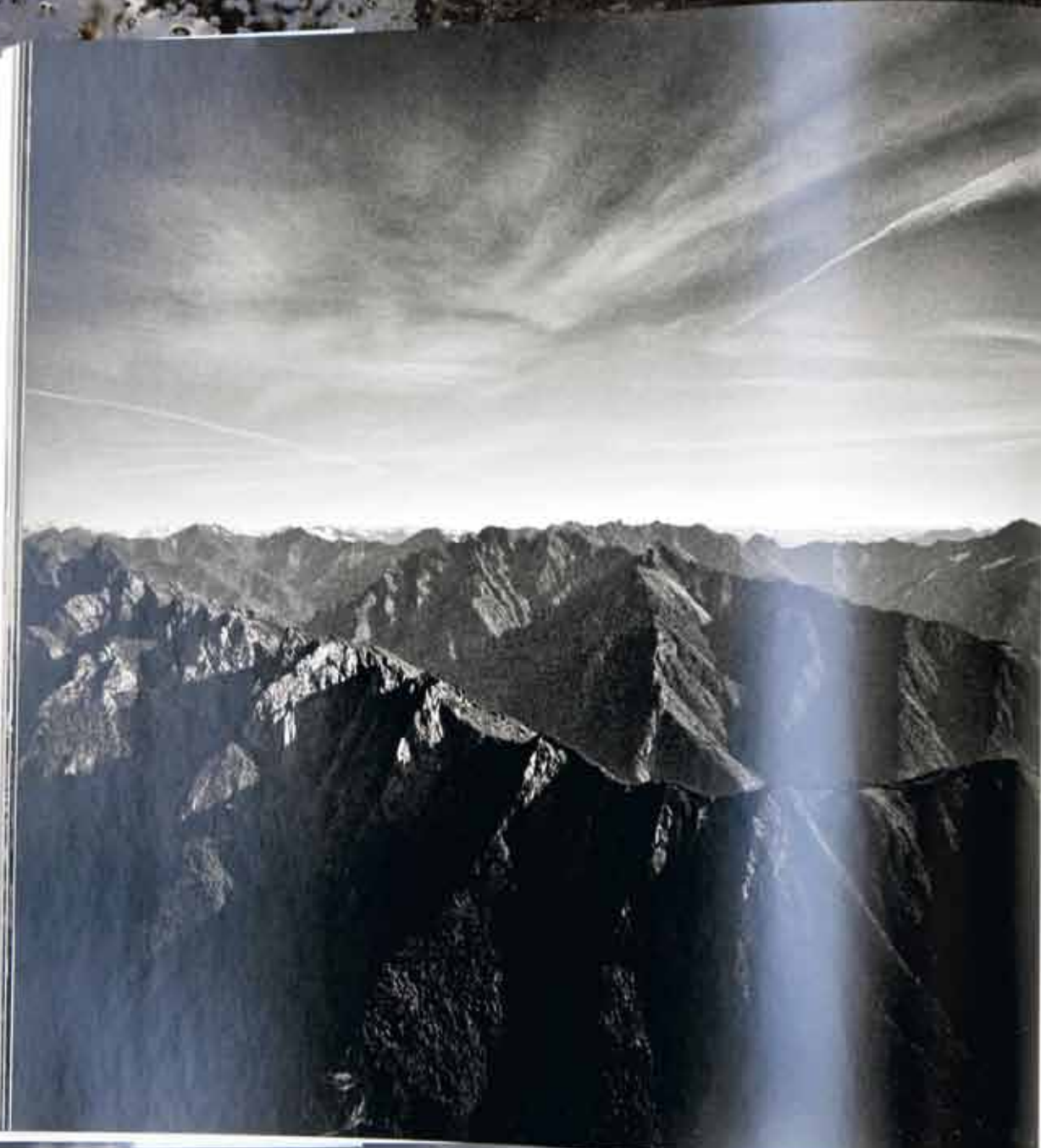

# domino

Design R&S Emmegi



Domino è una seduta d'attesa adattabile e componibile a proprio piacimento. È poltrona singola, divano a due o tre posti oppure composizione ad angolo, caratterizzata da versatilità, linearità ed eleganza. Costituita da una struttura in legno con imbottitura in resina espansa e piedi in alluminio anodizzato o in tubolare di acciaio a sezione quadrata con finitura cromata o verniciata nera. Domino può essere rivestita in pelle o tessuto, con supporto in velicren.

🔥 CL 1 IM  
Omologazione Ministero degli Interni  
(con rivestimento in Trevira o Sistema FR)  
Test resistenza EN 15373:2007  
EN 1728:2002

Domino is a modular reception chair, which can be adjusted as required. Versatile, linear and elegant, Domino is available in a single chair version, a 2/3 seater sofa version or a corner arrangement. It has a wooden structure, expanded polyurethane padding, feet in anodized aluminium or tubular steel with square cross-section, and a chrome-plated or black lacquer finish. Domino can be upholstered in leather or fabric, with a Velicren support.

🔥 CL 1 IM  
Home Ministry Approved  
(with Trevira or Sistema FR upholstery)  
Test resistenza EN 15373:2007  
EN 1728:2002

Domino est un siège d'attente à adapter et composer à volonté. Il peut se transformer en fauteuil individuel, en canapé à deux ou trois places ou en composition d'angle, se caractérisant par la flexibilité, la linéarité et l'élégance. Structure en bois avec garnissage en résine expansée, pieds en aluminium anodisé ou en acier tubulaire à section carrée avec finition chromée ou laquée noire. Domino peut être recouvert de cuir ou de tissu, avec support en velicren.

🔥 CL 1 IM  
Homologation Ministère de l'Intérieur  
(avec revêtement en Trevira ou Système FR)  
Test résistance EN 15373:2007  
EN 1728:2002

Domino ist ein Stuhl für das Wartezimmer, der nach Wunsch angepasst und zusammengesetzt werden kann. Er ist ein einzelner Sessel, ein Sofa mit zwei oder drei Sitzplätzen oder ein Ecksofa, der sich durch Vielseitigkeit, Geradlinigkeit und Eleganz auszeichnet. Struktur aus Holz mit Polsterung aus Hartschaumstoff, Füße aus eloxiertem Aluminium oder aus verchromtem oder schwarz lackiertem quadratischem Stahlrohr. Domino kann mit Leder oder Stoff bezogen sein, mit Unterlage aus Velicren.

🔥 Typgene CI 1 IM  
Zulassung durch das Innenministerium  
(mit Bezug aus Trevira oder FR-System)  
Widerstandstest EN 15373: 2007  
EN 1728: 2002

Domino es un asiento de espera adaptable y modular según se desee. Es sillón individual, sofá de dos o tres cuerpos o bien composición angular, caracterizado por versatilidad, linealidad y elegancia. Estructura de madera con tapizado de resina expandida, pies de aluminio anodizado o de acero tubular de sección cuadrada, con acabado cromado o pintura negra. Domino puede ser revestido de piel o tela, con soporte de velicren.

🔥 CL 1 IM  
Homologación del Ministerio del Interior  
(con revestimiento de Trevira o Sistema FR)  
Prueba de Resistencia EN 15373: 2007  
EN 1728: 2002

## disegni tecnici / technical drawings / dessins techniques / technischen Zeichnungen / diseños técnicos /

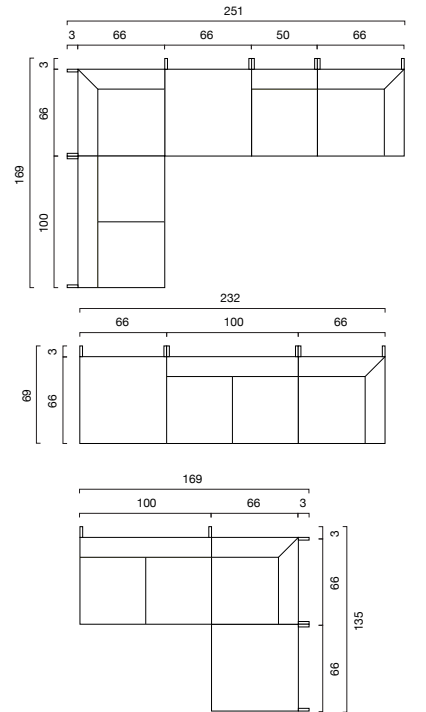
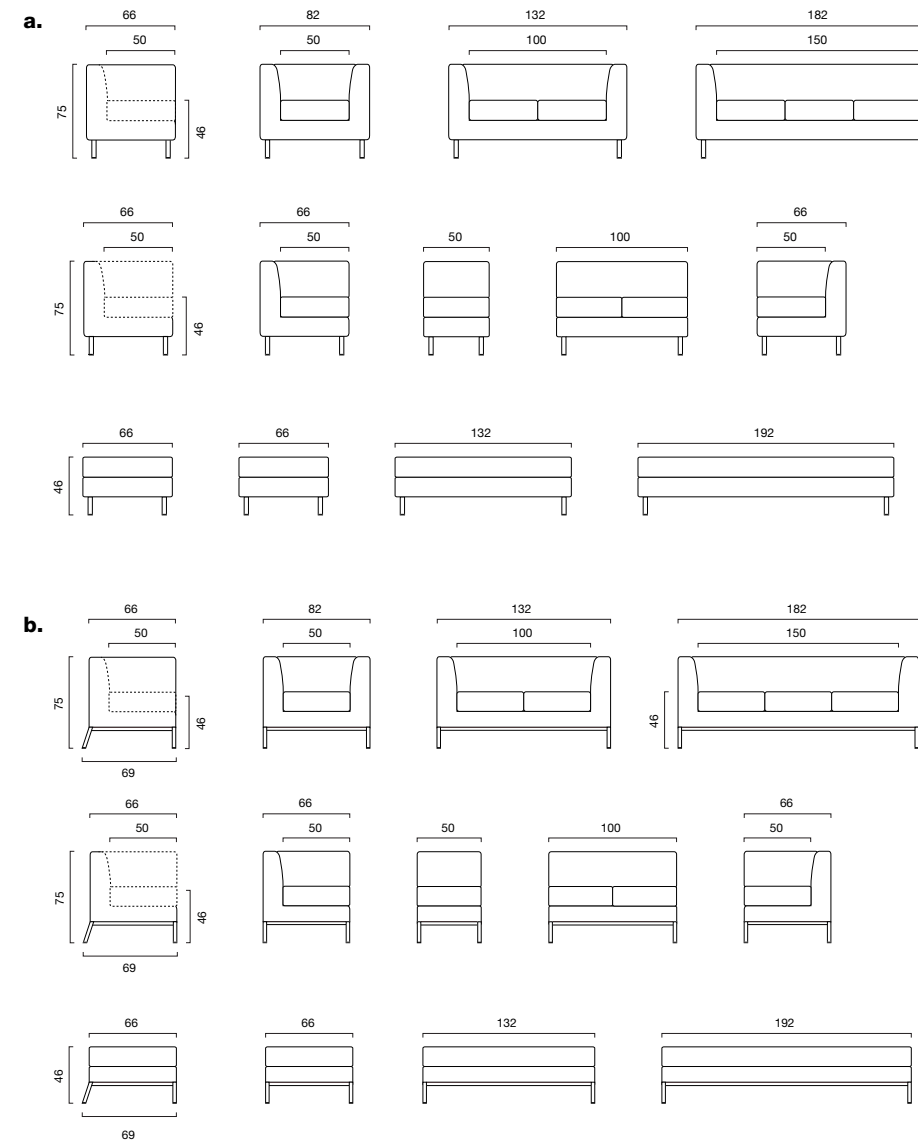

## modelli / models / modèles / Modelle / modelos /

34



35

finiture metallo / metal finish / finitions métal / Metallausführungen / acabados metal

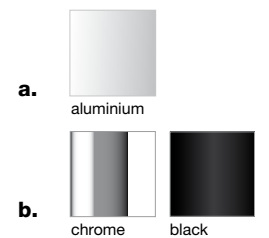

# milo



## Design R&S Emmegi

Divano multifunzionale. La struttura interna è realizzata in legno massello e pannello di fibra di legno duro. La seduta ha una imbottitura in poliuretano espanso, lo schienale ed i braccioli sono realizzati con imbottitura in poliuretano espanso ricoperti da un rivestimento in resinato. Piedini realizzati in tubolare di acciaio.

The Milo collection includes a chair version and a 2/3-seater sofa version. It has an inner structure in solid wood. Its base has anodized aluminium feet with chrome-plated steel back supports. The seat and backrest are upholstered in fabric or leather with square pattern quilting.

Milo est une collection comprenant le fauteuil et le canapé à deux et trois places. Structure interne en bois massif. Base réalisée avec des pieds en aluminium anodisé et supports du dossier en acier chromé. L'assise et le dossier sont recouverts de tissu ou de cuir matelassé.

Milo ist eine Kollektion, die den Sessel und das Sofa mit zwei oder drei Sitzplätzen einschließt. Der innere Aufbau ist aus Massivholz. Das Untergestell ist mit Füßen aus eloxiertem Aluminium realisiert, und die Rückenlehnenhalterungen sind aus verchromtem Stahl. Die Sitzfläche und die Rückenlehne sind mit Stoff oder Leder bezogen und quadratisch abgesteppt.

Milo es una colección que incluye el sillón y el sofá de dos o tres cuerpos. La estructura interna está realizada de madera maciza. La base está realizada con pies de aluminio anodizado y los soportes del respaldo son de acero cromado. El asiento y el respaldo están revestidos con tela o piel con recuadros respunteados.

**finiture metallo / metal finish / finitions métal / Metallausführungen / acabados metal**

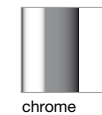

### 36 modelli / models / modèles / Modelle / modelos /



### disegni tecnici / disegni tecnici / disegni tecnici / disegni tecnici / disegni tecnici /

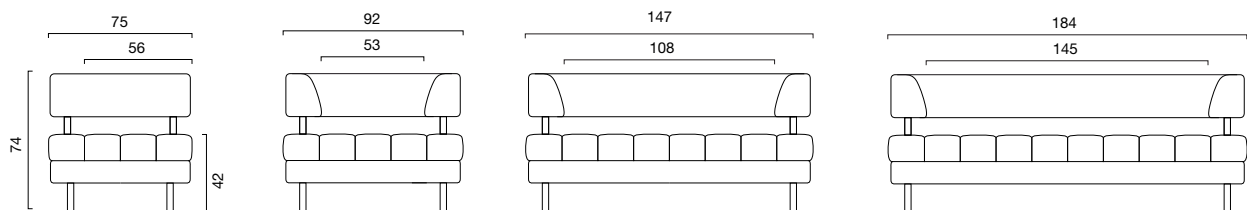

# kea

## Design R&S Emmegi

Kea, poltrona singola o divano a due o tre posti dal disegno semplice, lineare, accogliente, ideale per l'ufficio, la casa, le sale attese o lettura. Struttura in multistrati di legno con imbottitura in poliuretano espanso rivestita nei tessuti o nelle pelli della cartella colori Emmegi. Telaio in tubo di acciaio verniciato nero, o cromato su piedini con piede di appoggio regolabile e autolivellante.

☛ Omologazione in CL 1 IM (con rivestimento Sistema FR)

Kea, in a single chair version or a 2/3-seater sofa version with a simple, clear-cut and attractive design, is ideal for offices, homes, waiting and reading rooms. It has a plywood structure with expanded polyurethane padding upholstered in fabric or leather. The frame is in tubular steel with black lacquer or chrome-plated finish, with adjustable, self-levelling feet.

☛ CL 1 IM approved (with Sistema FR upholstery)

Kea, fauteuil individuel ou canapé à deux ou trois places au design simple, linéaire et accueillant. C'est l'idéal pour le bureau, la maison et les salles d'attente ou de lecture. Structure en bois multiplis avec garnissage en polyuréthane expansé recouvert de tissu ou de cuir. Bâti en acier tubulaire laqué noir ou chromé sur base avec pied d'appui réglable et de mise à niveau.

☛ Homologation en CL 1 IM (avec revêtement Système FR)

Kea, einzelner Sessel oder Sofa mit zwei oder drei Sitzplätzen mit einem einfachen, linearen, einladenden Design, ideal für das Büro, für zuhause, für Wartezimmer oder Lesesäle. Struktur aus Mehrschichtenholz mit PUR-Schaumpolsterung mit Stoff oder Leder bezogen. Gestell aus schwarz lackiertem Stahlrohr, oder verchromt auf Füßen mit verstellbarem und selbst nivellierendem Stützfuß.

☛ Typgenehmigung Cl 1 IM (mit Bezug FR-System)

Kea, sillón individual o sofá de dos o tres cuerpos de diseño simple, lineal, acogedor, ideal para la oficina, la casa, las salas de espera o lectura. Estructura de multicapas de madera con tapizado de poliuretano expandido revestido con telas o piel. Armazón de tubo de acero pintado negro, o cromado sobre soportes con pie de apoyo regulable y autonivelantes.

☛ Homologación en CL 1 IM (con revestimiento Sistema FR)

### modelli / models / modèles / Modelle / modelos /



### disegni tecnici / technical drawings / dessins techniques / technischen Zeichnungen / diseños técnicos /

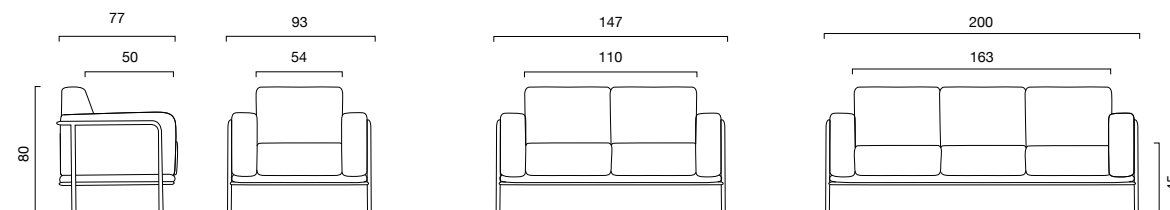

**finiture metallo / metal finish / finitions métal / Metallausführungen / acabados metal**

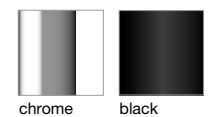

# park



modelli / models / modèles / Modelle / modelos /



38

disegni tecnici / technical drawings / dessins techniques / technischen Zeichnungen / diseños técnicos /

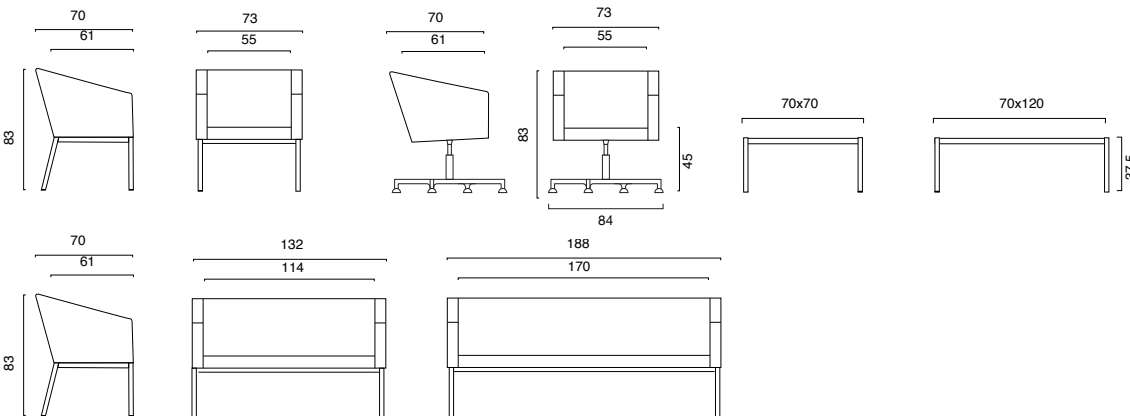

# Design R&S Emmegi

Park divano disponibile a un posto, due posti o poltrona con base girevole in alluminio. Rivestimento in pelle, ecopelle, tessuto. Struttura portante in tubolare di acciaio a sezione quadra di acciaio, verniciata a polveri epossidiche nere o cromata, sedile e schienale in multistrati di legno con imbottitura in poliuretano flessibile.

Park comes in a 1/2-seater sofa version or a chair version with a polished aluminium or black swivel base with glides. It is upholstered in leather, eco-leather or fabric. It has a load-bearing structure in tubular steel with a square cross-section, with black epoxy lacquer or chrome-plated finish. The seat and backrest are in plywood with flexible polyurethane padding.

Canapé Park à une ou deux places ou fauteuil avec piètement pivotant en aluminium poli ou noir avec pieds. Revêtement en cuir, en skaï ou en tissu. Structure portante en acier tubulaire à section carrée, laqué époxy noir ou chromé, assise et dossier en bois multiplis avec garnissage en polyuréthane flexible.

Das Sofa Park ist mit einem oder zwei Plätzen oder als Sessel mit Drehgestell aus Glanzaluminium oder schwarz mit Füßen verfügbar. Bezug aus Leder, Eco-Leder, Stoff. Tragstruktur aus quadratischem Stahlrohr mit schwarzer Epoxypulverbeschichtung oder verchromt, Sitzfläche und Rückenlehne aus Mehrschichtenholz mit Polsterung aus flexiblem Polyurethanschaum.

Park sofá disponible en un cuerpo, dos cuerpos o sillón con base giratoria de aluminio brillante o negro con pies. Revestimiento de piel, piel sintética o tela. Estructura portante de tubo de acero de sección cuadrada de acero, pintura en polvo tipo epoxi negra o cromada, asiento y respaldo en multicapas de madera con tapizado de poliuretano flexible.

finiture metallo / metal finish / finitions métal / Metallausführungen / acabados metal /

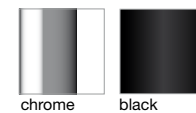

# elis



modelli / models / modèles / Modelle / modelos /



disegni tecnici / technical drawings / dessins techniques / technischen Zeichnungen / diseños técnicos /

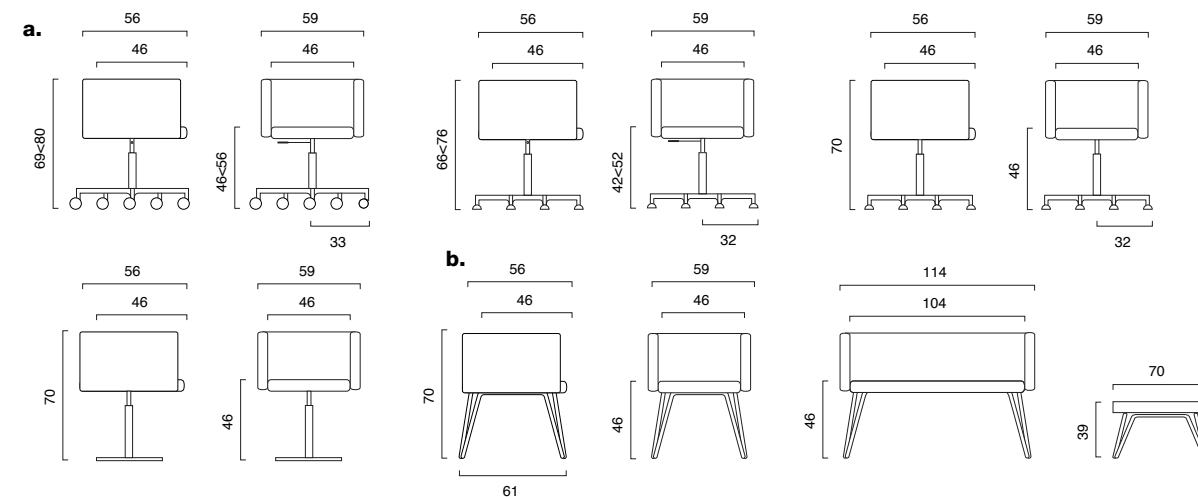

# Design R&S Emmegi

Elis è una poltroncina studiata per momenti d'attesa e reception, per l'ufficio o le sale riunioni. La sua versatilità è accompagnata da una struttura tecnica affidabile, con una scocca in multistrati di faggio sagomata e l'imbottitura in poliuretano espanso. Predisposta per diverse tipologie di basi, è adattabile ad ogni contesto.

The Elis chair has been designed for waiting and reception areas, offices and meeting rooms. Versatile with reliable technical features, the chair has a shaped beech plywood structure with expanded polyurethane padding. It can be fitted with various types of base, and adapts to all interiors.

Elis est un petit fauteuil destiné aux moments d'attente et de réception, pour le bureau ou les salles de réunions. Sa flexibilité s'associe à une structure technique fiable, avec coque en hêtre multiplis façonnée et garnissage en polyuréthane expansé. Prévu pour différents types de bases, il s'adapte à n'importe quel contexte.

Elis ist ein Sessel, der für die Momente im Wartezimmer und am Empfang, für Büros oder Sitzungsräume entwickelt wurde. Seine Vielseitigkeit wird durch eine technisch zuverlässige Struktur begleitet, mit einem Aufbau aus geformtem Buchenmehrschichtenholz und PUR-Schaumpolsterung. Er wurde für verschiedene Untergestelltypen entwickelt und kann jedem Kontext angepasst werden.

Elis es un sillón estudiado para momentos de espera y recepción, para la oficina o las salas para reuniones. Su versatilidad es acompañada por una estructura técnica fiable, con un bastidor multicapas de haya moldeada y el tapizado es de poliuretano expandido. Preparada para diferentes tipos de bases, se adapta a cualquier contexto.

finiture metallo / metal finish / finitions métal / Metallausführungen / acabados metal /

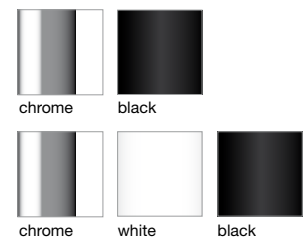

a.

b.

# business class



## Design Favaretto & Partners

Business Class è una poltrona attesa per lounge di hotel, grandi spazi o l'ufficio direzionale nelle versioni fissa o girevole. La struttura è in piatto di acciaio cromato, bianco o nero per il modello con telaio fisso e con piastra di acciaio nera o bianca per il modello girevole. La seduta è poliuretano schiumato con interno in tubolare di acciaio. Cuscino con imbottitura in poliuretano espanso con rivestimento in tessuto o pelle.

Business Class is a reception chair for hotel lounges, large spaces or executive offices. Available in a fixed version or a swivel version. The chair with a fixed base version has a sheet steel structure with chrome-plated, white or black finish, whereas the swivel base version is in steel plate with black or white-plated finish. The seat is in foamed polyurethane with a tubular steel interior. Cushion with expanded polyurethane padding with upholstery in fabric or leather.

Business Class est un fauteuil d'attente pour le hall des hôtels, les grands espaces ou le bureau de la direction, dans les versions fixe ou pivotante. Structure constituée d'un plateau en acier chromé blanc ou noir pour le modèle avec bâti fixe et d'une plaque d'acier noire ou blanc pour le modèle pivotant. Assise en polyuréthane expansé avec intérieur en acier tubulaire. Coussin avec garnissage en polyuréthane expansé et revêtement en tissu ou en cuir.

Business Class ist ein Sessel für Wartezimmer, für die Hotellounge, große Räume oder Direktionsbüros in fester oder drehbarer Version. Die Struktur ist aus weißem oder schwarzem verchromtem Flachstahl für das Modell mit festem Rahmen und aus schwarzem oder weißem Flachstahl für das drehbare Modell. Die Sitzfläche ist aus PUR-Schaumpolsterung und einem Innenbereich aus Stahlrohr. Kissen mit PUR-Schaumpolsterung mit Bezug aus Stoff oder Leder.

Business Class es un sillón de espera para vestíbulos de hoteles, grandes espacios o la oficina ejecutiva en las versiones fija y giratoria, caracterizada por los lineamientos bien definidos de las costuras a lo largo de los ángulos que diseñan su perfil. La estructura es de pletina de acero cromado, blanco o negro para el modelo con armazón fijo y con pletina de acero negro o blanco para el modelo giratorio. El asiento es de espuma de poliuretano con interior de tubos de acero. Cojín con tapizado de espuma de poliuretano expandido, con revestimiento de tela o piel.

### finiture metallo / metal finish / finitions métal / Metallausführungen / acabados metal

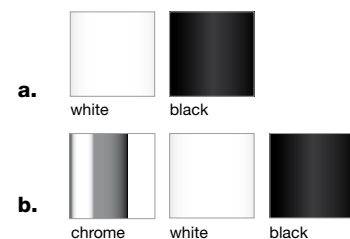

# skyline



## Design R&S Emmegi

La collezione include la poltrona singola e il divanetto a due posti, inoltre una poltroncina girevole con lo schienale alto completa la gamma. Seduta in poliuretano schiumato a freddo con struttura in acciaio, rivestimento in tessuto o pelle. Telaio in tubo di acciaio cromato o verniciato con piedi in gomma antiscivolo, base in alluminio a quattro razze con piedini o cinque razze con ruote.

The collection includes a single chair version and a 2-seater couch version, as well as a swivel chair version with a high backrest to complete the range. The seat is in cold-foamed polyurethane with a steel frame, and is upholstered in fabric or leather. It has a tubular steel frame with a chrome-plated or lacquer finish, with non-slip rubber feet, a 4-spoke aluminium base with feet, or a 5-spoke base with castors.

La collection comprend le fauteuil individuel et le canapé à deux places. Un petit fauteuil pivotant avec dossier haut complète la gamme. Assise en polyuréthane estampé à froid avec structure en acier et revêtement en tissu ou en cuir. Bâti en acier tubulaire chromé ou laqué avec pieds en caoutchouc antidérapant, piètement en aluminium 4 branches avec pieds ou 5 branches avec roulettes.

Die Kollektion schließt den einzelnen Sessel und das Sofa mit zwei Sitzplätzen ein, außerdem vervollständigt ein Drehsessel mit hoher Rückenlehne das Angebot. Sitzfläche aus kaltgeschäumtem Polyurethan mit Stahlstruktur, Bezug aus Stoff oder Leder. Verchromter oder lackierter Stahlrohrrahmen mit rutschsicheren Gummifüßen, vierarmiges Untergestell aus Aluminium mit Füßen oder fünfarmiges Untergestell mit Rollen.

La colección incluye el sillón individual y el pequeño sofá de dos cuerpos, además un pequeño sillón giratorio con el respaldo alto completa la gama. Asiento de espuma de poliuretano en frío con estructura de acero, revestimiento de tela o piel. Armazón de tubo de acero cromado o pintado con pies de goma antideslizante, base de aluminio de cuatro radios con pies o cinco radios con ruedas.

### finiture metallo / metal finish / finitions métal / Metallausführungen / acabados metal /

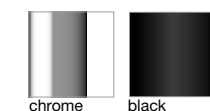

## 40 modelli / models / modèles / Modelle / modelos /



## modelli / models / modèles / Modelle / modelos /



## disegni tecnici / technical drawings / dessins techniques / technischen Zeichnungen / diseños técnicos /

## disegni tecnici / technical drawings / dessins techniques / technischen Zeichnungen / diseños técnicos /

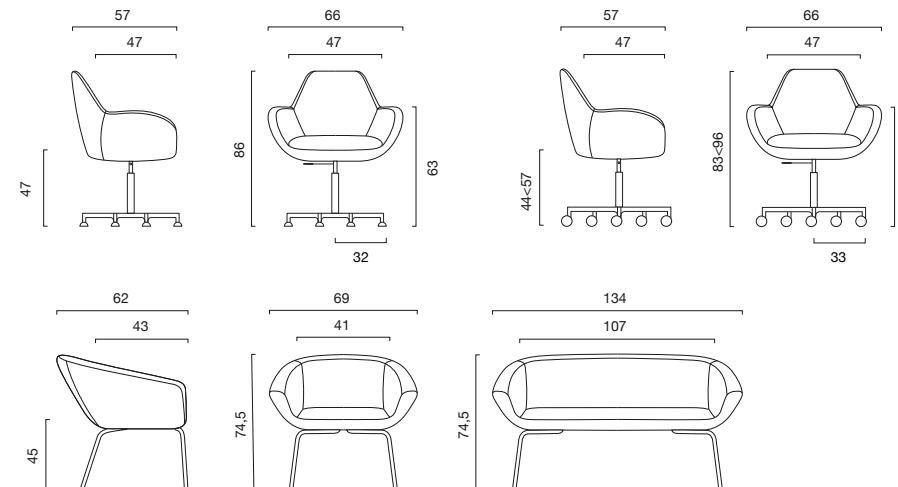
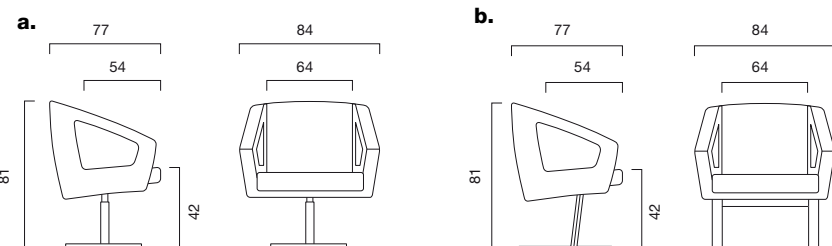

# sulu

Design Angelo Dall'Aglio



Sulu è una sedia versatile, ideata per spazi di attesa e reception. Si può utilizzare singola o aggregabile su barra. In modo pratico ed elegante arreda gli spazi rendendoli ospitali, si rivela piacevole, comoda e decisamente confortevole. L'innovativo utilizzo dei materiali e il particolare disegno caratterizzato dall'uso dei colori, tono su tono o a contrasto, definiscono calde tonalità e finiture ricercate in sintonia con le richieste del mercato. L'aspetto "bold" identifica questa poltroncina e la sua linea grafica si rincorre e incrociandosi, disegna forme nuove e armoniche. Seduta in poliuretano schiumato a freddo con struttura in acciaio, rivestimento in tessuto o pelle. Struttura in acciaio verniciato bianco o nero con piedi in gomma antiscivolo.

Sulu is a versatile chair, which has been created for waiting and reception areas. It can be used as a separate chair or fitted with other chairs on a beam. Sulu furnishes spaces in a practical and elegant way, making them attractive. It is charming, convenient and definitely comfortable. Its innovative materials and special design, featuring tone-on-tone or contrasting colours, create warm shades and refined finishes to meet market demands. This chair has a distinctly bold aspect with a continuous contour that intersects to create new harmonious shapes. The seat is in cold-foamed polyurethane with a steel frame, upholstered in fabric or leather. It has a steel frame with black or white lacquer finish, with non-slip rubber feet.

Sulu est une chaise flexible, conçue pour les lieux d'attente et de réception. On peut l'utiliser seule ou la fixer avec d'autres sur une barre. Elle meuble de façon pratique et élégante les espaces, en les rendant accueillants. Elle est agréable, pratique et très confortable. L'utilisation innovatrice des matériaux et le design particulier caractérisé par l'emploi des couleurs, ton sur ton ou en contraste, définissent des nuances chaudes et des finitions recherchées pour répondre aux demandes du marché. L'aspect « bold » identifie ce petit fauteuil et sa ligne graphique s'entrecroise, en dessinant de nouvelles formes harmonieuses. Assise en polyuréthane estampé à froid avec structure en acier et revêtement en tissu ou en cuir. Structure en acier laqué blanc ou noir avec pieds en caoutchouc antidérapant.

Sulu ist ein vielseitiger Stuhl, der für Warte- und Empfangsbereiche entwickelt wurde. Er kann einzeln oder durch Anbringen an einer Tragstange verwendet werden. Er richtet die Räume praktisch und elegant ein und gestaltet sie einladend, er stellt sich als angenehm, bequem und ausgesprochen gemütlich heraus. Die innovative Verwendung der Materialien und das besondere Design, das sich durch die Verwendung der Farben, Ton in Ton oder im Kontrast, auszeichnet, weisen warme Farbtöne und Verarbeitungen in Übereinstimmung mit den Marktanforderungen auf. Der Aspekt "bold" kennzeichnet diesen Sessel, und der Verlauf seiner aufeinander treffenden graphischen Linie zeichnet neue und harmonische Formen. Sitzfläche aus kaltgeschäumtem Polyurethan mit Stahlstruktur, Bezug aus Stoff oder Leder. Struktur aus weiß oder schwarz lackiertem Stahl mit Füßen aus rutschsicherem Gummi.

Sulu es una silla versátil, ideada para espacios de espera y recepción. Se puede utilizar de manera individual o incorporándola al mostrador. De manera práctica y elegante decora los espacios haciéndolos acogedores, es agradable, cómoda y decididamente confortable. El innovador uso de los materiales y el particular diseño caracterizado por el uso de los colores, tono sobre tono o en contraste, definen tonalidades cálidas y acabados refinados en sintonía con los requerimientos del mercado. El aspecto "bold" identifica a este sillón y su línea gráfica en líneas que al cruzarse, diseña formas nuevas y armónicas. Asiento de espuma de poliuretano en frío con estructura de acero, revestimiento de tela o piel.

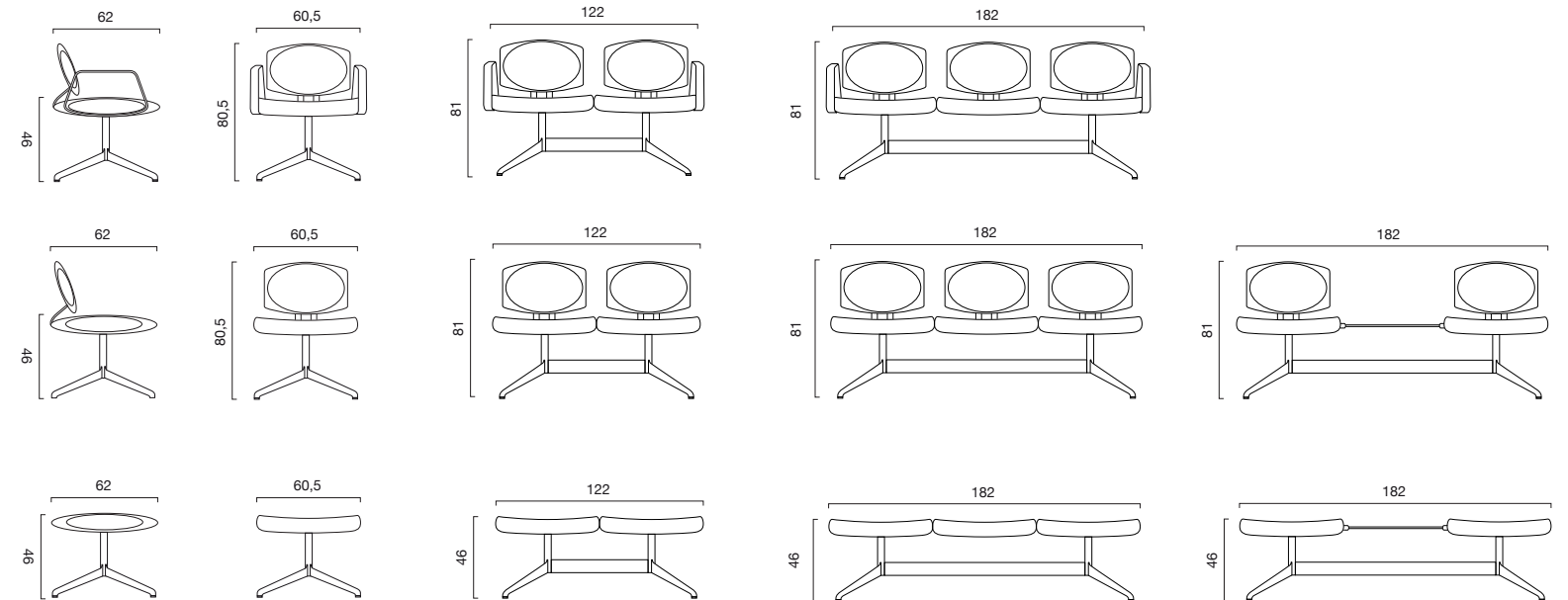

finiture metallo / metal finish / finitions métal / Metallausführungen / acabados metal

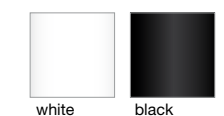

# kone

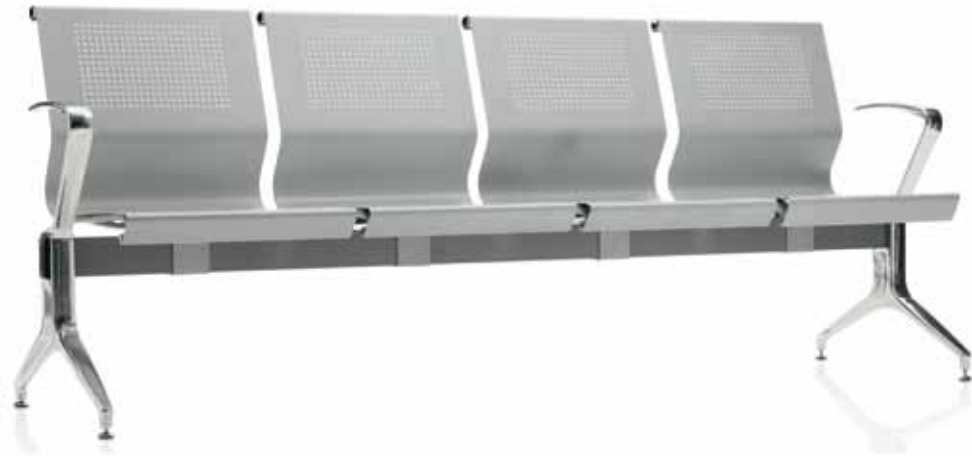

modelli / models / modèles / Modelle / modelos /



44

disegni tecnici / technical drawings / dessins techniques / technischen Zeichnungen / diseños técnicos /

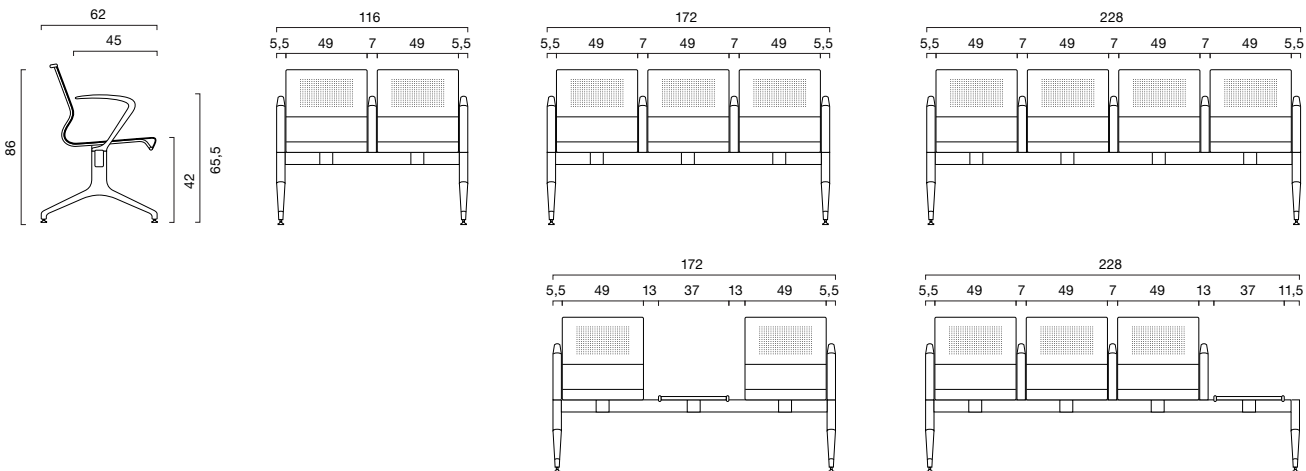

## Design R&S Emmegi

Kone è una seduta modulare su trave che soddisfa diverse esigenze di spazi attesa. È realizzata con sedute monoscocca in lamiera di acciaio, parzialmente forata, barra di supporto in tubolare di acciaio rettangolare, base e braccioli in alluminio pressofuso lucidato. La verniciatura è a polveri epossidiche antigraffio. Composizioni disponibili da 2 a 5 posti.

Test Resistenza EN 15373: 2007  
EN 1728: 2002

Kone is a modular seating system on a beam, which meets the various needs of waiting areas. It has single frame seats in partially perforated steel plate, supporting bar in rectangular steel tube, base and armrests in polished die-cast aluminium. It comes with an aluminium non-scratch epoxy powder finish. It is available in arrangements of 2 to 5 seats.

Resistance Tests EN 15373: 2007  
EN 1728: 2002

Kone est un siège modulaire sur poutre qui satisfait les exigences des espaces d'attente. Assise monocoque en tôle d'acier, barre de support en tube d'acier rectangulaire, base et accoudoirs en aluminium moulé sous pression poli. Disponible avec petite table intermédiaire ou terminale en tôle d'acier. Laquage époxy anti-rayures gris aluminium. Compositions disponibles de 2 à 5 places.

Test Résistance EN 15373: 2007  
EN 1728: 2002

Kone ist ein modulares Sitzsystem auf Trägern, das allen Bedürfnissen in Wartebereichen gerecht werden kann. Die Sitzflächen sind aus einem durchgehenden, partiell gelochten Blechaufbau und aus einem Stahlrohrträger mit quadratischem Querschnitt gefertigt; das Grundgestell und die Armlehnen bestehen aus poliertem Alu-Druckguss. Erhältlich mit Zwischen- oder Seitentisch aus Stahlblech. Kratzfeste Epoxidpulver-Lackierung. Als 2er bis 5er-Sitzkomposition erhältlich.

Widerstandstest EN 15373: 2007  
EN 1728: 2002

Kone es un asiento modular sobre vigas que cumple con las diferentes exigencias de espacios de espera. Está realizado con asientos con monobastidor de chapa de acero, parcialmente perforada, barra de soporte de acero tubular rectangular, base y brazos de aluminio fundido a presión bruñido. La pintura es de polvos epoxi anti-rayas gris aluminio. Composiciones disponibles de 2 a 5 cuerpos.

Prueba de Resistencia EN 15373: 2007  
EN 1728: 2002

# joint



modelli / models / modèles / Modelle / modelos /



disegni tecnici / technical drawings / dessins techniques / technischen Zeichnungen / diseños técnicos /

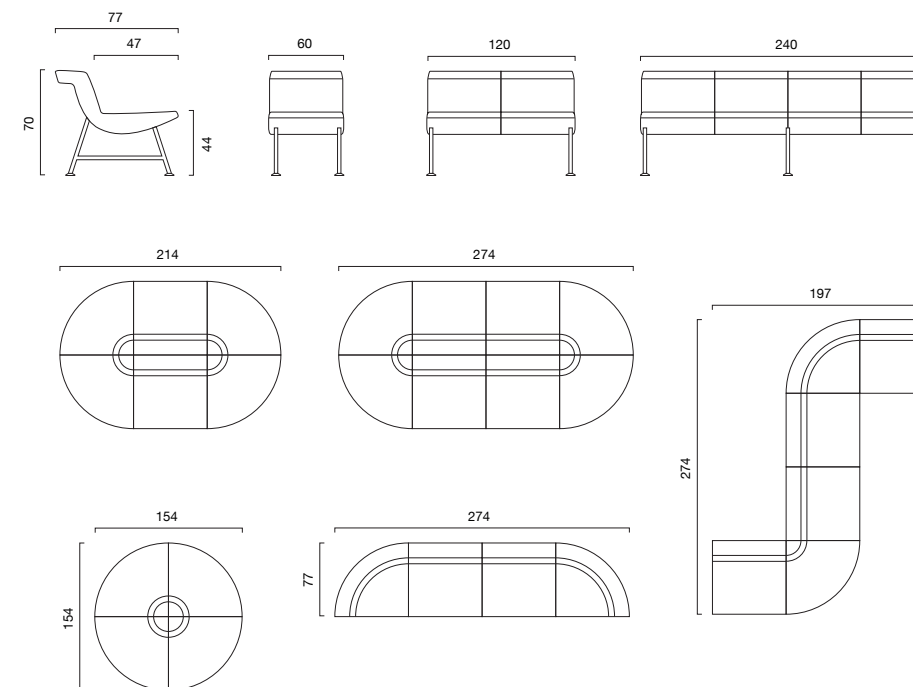

## Design R&S Emmegi

Joint è una gamma di sedute a disposizione variabile per piccole zone relax o ampi spazi di attesa. Il sistema semplificato di assemblaggio permette di comporre configurazioni personalizzate lineari, curvilinee o compatte. Struttura della seduta in tubo di acciaio con imbottitura in poliuretano schiumato a freddo flessibile. Gambe di sostegno in tubo di acciaio cromato con piede di appoggio al pavimento regolabile e autolivellante.

Omologazione in CL 1 IM (con rivestimento in Trevira o Sistema FR)

Joint is a versatile collection of chairs for small relaxation areas or spacious waiting areas. Its simplified assembly system allows customised linear, curved or compact configurations to be created. The seat is in fire-retardant foamed polyurethane padding with inner structure in steel. The support legs are in chrome-plated tubular steel with self-levelling and adjustable feet.

CI 1 IM approved (with Trevira upholstery)

Joint est une gamme de sièges à disposition variable pour petites zones relax ou grands espaces d'attente. Le système simplifié d'assemblage permet de composer des configurations personnalisées linéaires, curvilignes ou compactes. Assise avec garnissage en polyuréthane estampé ignifuge et structure interne en acier. Montants de soutien en tube d'acier chromé avec pied d'appui au sol réglable et se mettant automatiquement de niveau.

Homologation en CL 1 IM (avec revêtement en Trevira)

Joint ist eine Stuhlpalette mit variabler Anordnung für kleine Erholungsbereiche oder große Wartebereiche. Das vereinfachte Montagesystem ermöglicht es, individuelle lineare, gebogene oder kompakte Konfigurationen zusammenzustellen. Sitzfläche mit feuerhemmender PUR-Schaumpolsterung mit innerem Aufbau aus Stahl. Stützbeine aus verchromtem Stahlrohr mit verstellbarem und selbst nivellierendem Stützfuß auf dem Fußboden.

Typpenehmigung CI 1 IM (mit Bezug aus Trevira)

Joint es una gama de asientos a disposición variable para pequeñas zonas relax o amplios espacios de espera. El sistema simplificado de ensamblaje permite realizar configuraciones personalizadas lineales, curvilineas o compactas. Asiento con tapizado de espuma de poliuretano ignifugo con estructura interna de acero. Patas de soporte de tubo de acero cromado con pie de apoyo al suelo regulable y autonivelante.

Homologación en CL 1 IM (con revestimiento de Trevira)

finiture metallo / metal finish / finitions métal / Metallausführungen / acabados metal /



chrome

45



color chart

# sistema

COMPOSITION  
63% Polyurethane  
16% Cotton  
21% Polyester

FASTNESS TO LIGHT  
(UNI EN ISO 105-B02) 4-5

ABRASION RESISTANCE  
(Martindale) UNI EN ISO  
12947:2000 300000 rubs



C



C939 Tabacco



C005 Nero C346 Grigio piombo C008 Testa di moro C054 Prugna C028 Granata C014 Geranio



C068 Arancio C070 Girasole C010 Panna C073 Bianco C072 Blu C956 Celeste



C071 Verde chiaro

48

# sistema micro

COMPOSITION  
63% Polyurethane  
16% Cotton  
21% Polyester

FASTNESS TO LIGHT  
(UNI EN ISO 105-B02) 4-5

ABRASION RESISTANCE  
(Martindale) UNI EN ISO  
12947:2000 300000 rubs



C



CM42 Marrone



CM05 Nero CM15 Blu notte CM25 Pistacchio CM89 Granata CM69 Corallo CM68 Pesca



CM71 Giallo pallido CM82 Viola

I colori sono puramente indicativi / Colours are only indicative

# extrema au

COMPOSITION  
63% Polyurethane  
37% Cotton

FASTNESS TO LIGHT  
(UNI EN ISO 105 B02:2001  
(Xenotest) 5-6 (blue scale)

PERSPIRATION RESISTANCE  
(UNI EN ISO 105 E04:98  
Acid alkaline 4-5

ABRASION RESISTANCE  
(Martindale) UNI EN ISO  
12947-2:2000 150000 rubs



R



2050 Cenere

Contiene "Ultra Fresh", un antimicrobico che addizionato durante le fasi di lavorazione crea una barriera difensiva contro acari, batteri e funghi evitando odori sgradevoli e allergie.

It contains "Ultra Fresh", an antimicrobial treatment added during production stages to create a barrier against dust mites, bacteria and fungi, preventing unpleasant odours and allergies.



0150 Bianco 0250 Crema 0550 Beige 0350 Ecrù 1150 Nocciola 2350 Giallo



0650 Terra di Siena 0750 Aragosta 1250 Marrone 1350 Testa di moro 2850 Glicine 2750 Ciclamino



0850 Scarlatto 0950 Granata 1050 Rosso cupo 1650 Verde chiaro 2450 Lime 1550 Verde scuro



1450 Tè verde scuro 0450 Kaki 2550 Lavanda 1850 Indaco 2650 Blu 1950 Blu di Prussia



1750 Azzurro ceruleo 2150 Grigio Piombo 2250 Nero

49

# mia

COMPOSITION  
47,5% Polyurethane  
31,5% Cotton  
21% Polyester

FASTNESS TO LIGHT  
(UNI EN ISO 105-B02) 5

FASTNESS TO RUBBING  
(UNI EN ISO 105-X12) 4-5

ABRASION RESISTANCE  
(Martindale) UNI EN ISO  
12947:2000 100000 rubs

S



H100 Bianco



H200 Nero H405 Testa di moro H404 Marrone H400 Crema H300 Geranio H304 Granata



H700 Blu H601 Grigio piombo H801 Verde bosco H301 Aragosta H402 Ecrù

I colori sono puramente indicativi / Colours are only indicative

# skill

COMPOSITION  
Polyurethane 1%  
Cotton/Polyester  
30%, Pvc 69%

FASTNESS TO LIGHT  
(UNI EN ISO 105-B02) 5

FASTNESS TO RUBBING  
(UNI EN ISO 105-X12) 4-5

ABRASION RESISTANCE  
(Martindale) UNI EN ISO  
12947 50000 rubs



S



L004 Beige

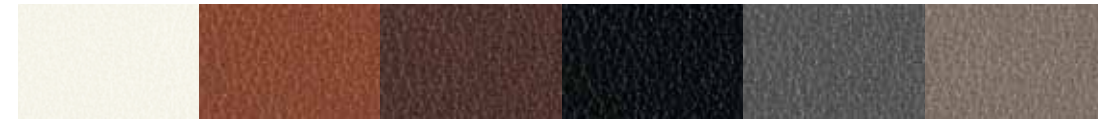

L001 Bianco L006 Tabacco L031 Marrone L024 Nero L023 Grigio L026 Tortora



L012 Arancio L011 Giallo L017 Verde L018 Verde Prato L009 Giallo Tenue L029 Giallo Verde



L034 Turchese L020 Azzurro Cielo L013 Rosso Rubino L032 Rosso Cupo L033 Prugna L015 Rosa Fluo



L022 Blu Notte

# 50 king L

COMPOSITION  
100% Polyester  
Trevira CS

FASTNESS TO LIGHT  
(UNI EN ISO 105-B02) 6

FASTNESS TO RUBBING  
(UNI EN ISO 105-X12) 4-5

ABRASION RESISTANCE  
(Martindale) UNI EN ISO  
12947:2000 60000 rubs  
±10%



D



7007 Cielo

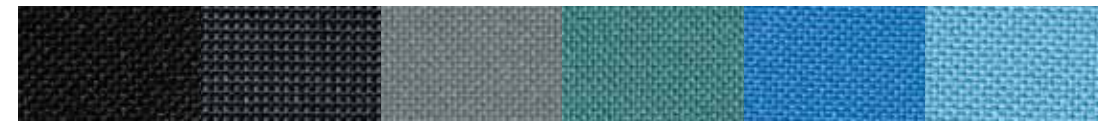

7133 Nero 7030 Bruno multicolore 7025 Grigio fumo 7005 Verde turchese 7070 Blu cobalto 7047 Celeste

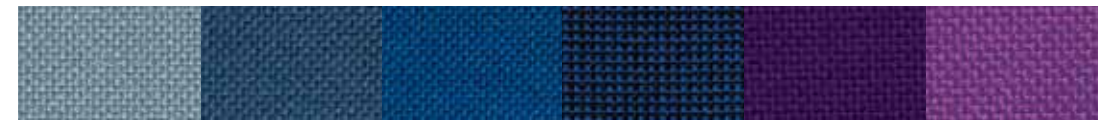

7625 Grigio freddo 7016 Blu ceruleo 7080 Blu di Parigi 7077 Blu multicolore 7054 Viola 7015 Prugna



7300 Corallo multicolore 7051 Melone 7011 Zucca 7027 Scarlatto 7008 Girasole 7010 Sabbia



7041 Verde chiaro 7004 Verde chiaro multicolore 7019 Verde prato 7020 Verde multicolore 7023 Verde pino

I colori sono puramente indicativi / Colours are only indicative

# king

COMPOSITION  
100% Polyester  
Trevira CS

FASTNESS TO LIGHT  
(UNI EN ISO 105-B02) 6

FASTNESS TO RUBBING  
(UNI EN ISO 105-X12) 4-5

ABRASION RESISTANCE  
(Martindale) UNI EN ISO  
12947:2000 50000 rubs  
±10%



D

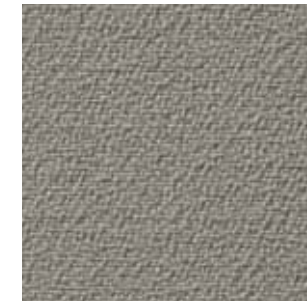

0025 Grigio fumo



0033 Nero 0028 Grigio antracite 0032 Multicolore bruno 0034 Multicolore grigio 0014 Sabbia 0046 Blu notte



0044 Prugna 0042 Granata 0018 Multicolore bruciata 0127 Scarlatto 0037 Corallo 0038 Zucca

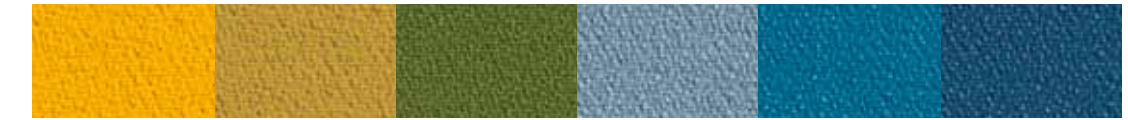

0008 Girasole 0081 Senape 0031 Verde oliva 0026 Azzurro ceruleo 0019 Cielo 0016 Blu ceruleo



0072 Multicolore blu elettrico 0071 Blu elettrico 0093 Multicolore celeste

# relax flex

COMPOSITION  
100% Polyester  
Trevira CS

FASTNESS TO LIGHT  
(UNI EN ISO 105-B02) 6

FASTNESS TO RUBBING  
(UNI EN ISO 105-X12) 4-5

ABRASION RESISTANCE  
(Martindale) UNI EN ISO  
12947:2000 100000 rubs  
±10%



D 51



DX10 Avorio



DX33 Nero DX07 Grigio fumo DX03 Panna DX17 Granata DX27 Scarlatto DX94 Corallo



DX30 Arancio DX98 Blu di Prussia DX80 Blu DX71 Blu elettrico DX26 Azzurro DX05 Sabbia



DX20 Verde muschio DX43 Verde oliva

I colori sono puramente indicativi / Colours are only indicative

# king L kat

COMPOSITION  
100% Polyester  
Trevira CS

FASTNESS TO LIGHT  
(UNI EN ISO 105-B02) 6  
(blue scale) - Xenotest

FASTNESS TO RUBBING  
(UNI EN ISO 105-X12) 4-5  
(grey scale)

ABRASION RESISTANCE  
(Martindale) UNI EN ISO  
12947-2 80000 rubs ±10%



F



1012 Crema



1025 Sabbia 1008 Beige 1033 Conchiglia 2003 Marrone 2007 Testa di moro 5001 Rubino



5014 Malva 4029 Bourdeaux 4032 Granata 4021 Ciliegia 3082 Tabacco 3094 Arancio



3005 Ocra 3030 Senape 7022 Oliva scuro 7019 Oliva 6001 Azzurro ceruleo 6091 Ceruleo



6034 Blu di Prussia 6013 Cobalto 6051 Blu di Persia 6052 Blu marino 6020 Lilla 8032 Cenere

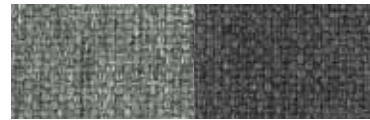

8006 Grigio 8011 Grigio piombo

# urban plus

COMPOSITION  
100% Recycled  
polyester

FASTNESS TO LIGHT  
(UNI EN ISO 105-B02) 6

FASTNESS TO RUBBING  
(UNI EN ISO 105-X12) 4

ABRASION RESISTANCE  
(Martindale) UNI EN ISO  
12947:2000 100000 rubs  
±10%



F

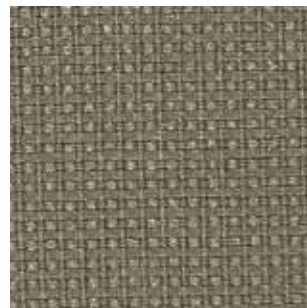

U212 Sabbia



U009 Nero U145 Grigio fumo U206 Grigio chiaro U190 Verde bosco U209 Blu elettrico U097 Celeste



U211 Granata U076 Zucca U158 Tabacco

# laser j

COMPOSITION  
100% Polyester  
Trevira CS

FASTNESS TO LIGHT  
(UNI EN ISO 105-B02) 6

FASTNESS TO RUBBING  
(UNI EN ISO 105-X12) 4-5

ABRASION RESISTANCE  
(Martindale) UNI EN ISO  
12947:2000 100000 rubs  
±10%



F



J003 Sabbia



J033 Nero J017 Feltro J027 Grigio chiaro J001 Bianco J006 Beige J036 Ebano



J048 Nocciola J082 Arancio J012 Minio J021 Scarlatto J014 Verde muschio J098 Blu



J083 Celeste J121 Verde Prato J004 Girasole

# xtreme plus

COMPOSITION  
100% Xtreme FR

FASTNESS TO LIGHT  
(UNI EN ISO 105-B02) 6

FASTNESS TO RUBBING  
(UNI EN ISO 105-X12) 4

ABRASION RESISTANCE  
(Martindale) UNI EN ISO  
12947:2000 100000 rubs  
±10%



F



X165 Bianco

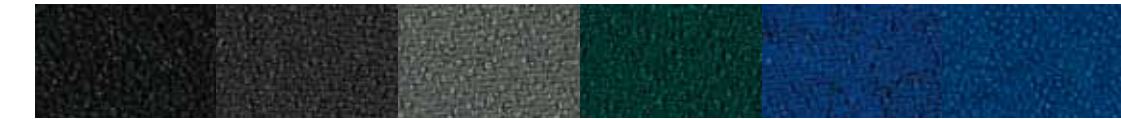

X009 Nero X046 Grigio fumo X141 Grigio X045 Verde scuro X100 Blu notte X082 Blu



X004 Carta da zucchero X030 Bordeaux X027 Marrone X076 Zucca X168 Salmone X079 Scarlatto



X091 Sughero X071 Ecrù X077 Verde Oliva X072 Girasole X096 Verde pastello X157 Celeste

# laser J flash

COMPOSITION  
100% Polyester  
Trevira CS

FASTNESS TO LIGHT  
(UNI EN ISO 105-B02) 6  
(blue scale) - Xenotest

FASTNESS TO RUBBING  
(UNI EN ISO 105-X12) 4-5  
(grey scale)

ABRASION RESISTANCE  
(Martindale) UNI EN ISO  
12947-2 100000 rubs  
±10%



M



9421 Carminio



9417 Rubino 9382 Ruggine 9416 Testa di moro 9309 Granito 9302 Zolfo 9114 Arenaria



9106 Basalto 9207 Marrone 9503 Malva 9515 Prugna 9596 Ametista 9606 Azzurro



9605 Azzurro ceruleo 9671 Blu 9614 Blu oltremare 9698 Blu di Prussia 9691 Verde petrolio 9729 Verde Pino



9707 Verde scuro 9721 Verde prato 9725 Oliva 9843 Cenere 9804 Grigio 9809 Grigio Piombo

54

# fame



COMPOSITION  
95% Pure wool  
5% Polyamide

FASTNESS TO LIGHT  
(UNI EN ISO 105-B02) 5

FASTNESS TO RUBBING  
(UNI EN ISO 105-X12) 4-5

ABRASION RESISTANCE  
(Martindale) UNI EN ISO  
12947:2000 200000 rubs



M



F036 Nocciola



F999 Nero F003 Grigio F020 Marrone F016 Arancio F119 Geranio F061 Granata



F436 Viola F026 Lilla F032 Blu notte F075 Blu F047 Celeste F040 Verde scuro



F044 Verde muschio F035 Verde F043 Giallo

I colori sono puramente indicativi / Colours are only indicative

# gaja



COMPOSITION  
100% Pure worsted  
wool

FASTNESS TO LIGHT  
(UNI EN ISO 105-B02) 5

FASTNESS TO RUBBING  
(UNI EN ISO 105-X12) 4-5

ABRASION RESISTANCE  
(Martindale) UNI EN ISO  
12947:2000 50000 rubs



M

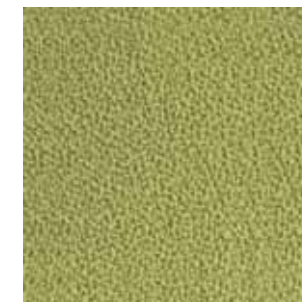

6851 Verde chiaro



6999 Nero 6019 Grigio scuro 6205 Marrone 6419 Rosso scuro 6403 Rosso 6316 Arancio



6211 Senape 6005 Blu notte 6004 Blu 6002 Carta da zucchero 6503 Lilla

# remix



COMPOSITION  
90% new wool,  
worsted,  
10% Nylon

FASTNESS TO LIGHT  
(UNI EN ISO 105-B02) 5-7

FASTNESS TO RUBBING  
(UNI EN ISO 105-X12) dry  
4-5, wet 4.

ABRASION RESISTANCE  
(Martindale) UNI EN ISO  
12947 100000 rubs



G



113 Avorio



123 Cenere 133 Grigio sabbia 143 Grigio 163 Grigio Piombo 173 Lavagna 183 Carbone



223 Sabbia 233 Ecrù 373 Cacao 383 Caffé 393 Nero d'Avorio 433 Tabacco



443 Bronzo 543 Corallo 643 Geranio 653 Granata 733 Denim 743 Blu ceruleo



753 Grigio scuro 773 Blu di Prussia 783 Testa di moro 823 Celadon 873 Ottanio 923 Grano



933 Oliva 953 Moka 973 Foresta Nera

55

I colori sono puramente indicativi / Colours are only indicative

**COMPOSITION**  
90% new wool,  
worsted,  
10% Nylon

**FASTNESS TO LIGHT**  
(UNI EN ISO 105-B02) 5-7

**FASTNESS TO RUBBING**  
(UNI EN ISO 105-X12) dry  
4-5, wet 4.

**ABRASION RESISTANCE**  
(Martindale) UNI EN ISO  
12947 80000 rubs



**G**

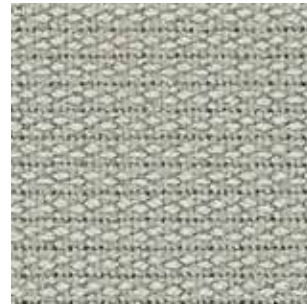

124 Cenere



132 Grigio 142 Grigio scuro 153 Ardesia 162 Ferro 184 Lavagna 192 Nero



212 Sabbia 223 Kaki 232 Kaki scuro 344 Bronzo 364 Marrone 373 Testa di moro



414 Grano 422 Giallo Napoli 432 Cadmio Arancio 442 Senape 453 Ambra 464 Terra di Siena



543 Pesca 552 Geranio 563 Aragosta 633 Rosa 642 Scarlatto 652 Cacao

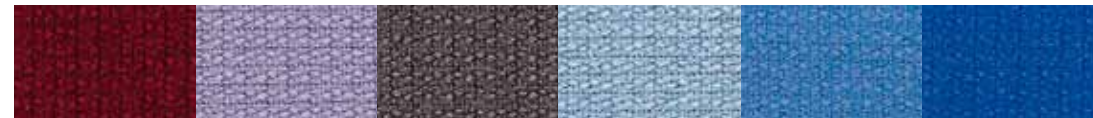

662 Granata 673 Lilla 683 Grigio viola 722 Azzurro ceruleo 732 Celeste 742 Blu Reale



752 Blu ceruleo 763 Blu cadetto 772 Blu 782 Blu di Prussia 793 Indaco 794 Blu notte



833 Acqua marina 843 Verde Prato 852 Turchese 862 Foglia di Té 872 Verde veronese 883 Oliva

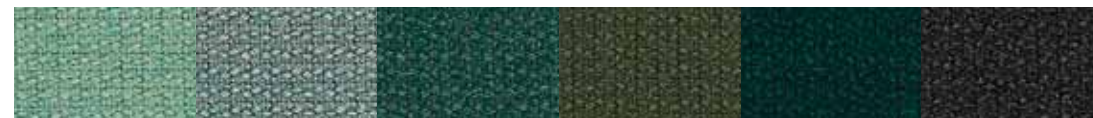

932 Té verde 953 Grigio verde 962 Muschio 972 Oliva scuro 982 Verde pino 993 Antracite

**COMPOSITION**  
90% new wool  
worsted,  
10% Nylon

**FASTNESS TO LIGHT**  
(UNI EN ISO 105-B02) 5-7

**FASTNESS TO RUBBING**  
(UNI EN ISO 105-X12) dry  
4-5, wet 4.

**ABRASION RESISTANCE**  
(Martindale) UNI EN ISO  
12947 80000 rubs



**Q**



105 Cenere

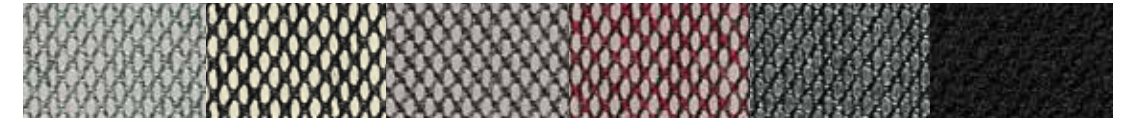

113 Grigio chiaro 124 Sale e Pepe 133 Grigio 144 Bianco multicolore 153 Grigio piombo 195 Nero



205 Panna 213 Sabbia 225 Sabbia multicolore 235 Ecu 245 Bronzo antico 253 Lucertola

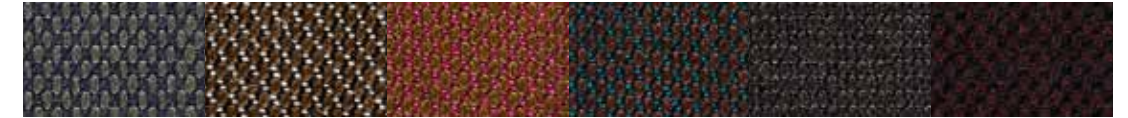

283 Grigio Blu 325 Marrone 333 Malva 353 Denim scuro 383 Antracite 395 Nero caffè



413 Grano 415 Ocra 425 Crema multicolore 453 Senape 465 Nero multicolore 515 Pesca



533 Vermiglio 553 Ciliegia 565 Mattone 645 Castagno 653 Fucsia 665 Bordeaux

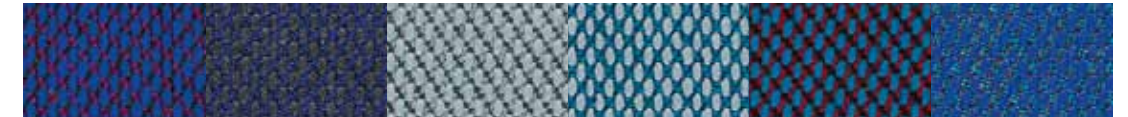

675 Blu oltremare 683 Viola 713 Azzurro ceruleo 733 Blu cadetto 745 Blu multicolore 753 Blu

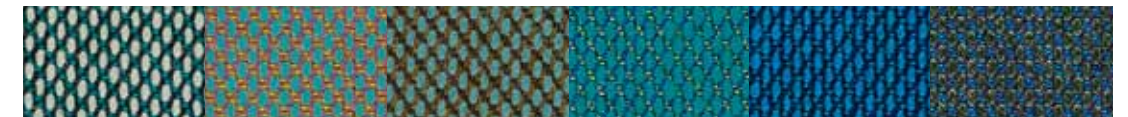

815 Celadon 825 Carta da zucchero 845 Turchese multicolore 853 Turchese 865 Bluette 883 Ardesia

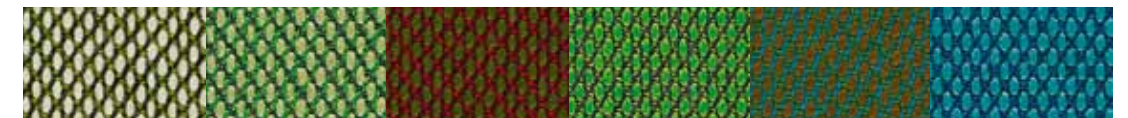

915 Verde chiaro 933 Verde pastello 945 Oliva 953 Verde prato 965 Verde militare 983 Caraibi

# divina melange 2

COMPOSITION  
100% Pure worsted wool

FASTNESS TO LIGHT  
(UNI EN ISO 105-B02) 5-7

FASTNESS TO RUBBING  
(UNI EN ISO 105-X12) dry 4-5, wet 4

ABRASION RESISTANCE  
(Martindale) UNI EN ISO 12947:2000 45000 rubs



Q



Q731 Celeste



Q180 Grigio

Q120 Grigio chiaro

Q681 Prugna

Q631 Viola

Q621 Fucsia

Q471 Verde scuro



Q421 Limone

Q521 Arancio

COMPOSITION  
100% Pure worsted wool

FASTNESS TO LIGHT  
(UNI EN ISO 105-B02) 5-7

FASTNESS TO RUBBING  
(UNI EN ISO 105-X12) dry 4-5, wet 4

ABRASION RESISTANCE  
(Martindale) UNI EN ISO 12947 45000 rubs



Q

# divina 3



T191 Nero

T181 Grigio scuro

T171 Grigio

T984 Marrone

T876 Muschio

T462 Senape



T536 Arancio

T552 Noce

T584 Rosso rubino

T623 Scarlatto

T652 Vinaccia

T666 Fucsia



T684 Viola scuro

T782 Blu elettrico

T742 Celeste

T826 Carta da Zucchero

T944 Verde Scuro

T856 Verde



T846 Verde Chiaro

58

T542 Minio

# pelle

COMPOSITION  
Genuine Leather

FASTNESS TO LIGHT  
(UNI EN ISO 105-B02) 4

FASTNESS TO RUBBING  
DRY (UNI EN ISO 11640)  
1000 rubs val. 5 Grey Scale  
WET (UNI EN ISO 11640)  
250 rubs val. 5 Grey Scale

TEAR RESISTANCE  
(UNI EN ISO 3377-1) >20N

P



826 Nocciola

La qualità della pelle è data da un'accurata selezione dei grezzi di origine Europea, spessore 0,9-1,0 mm, ottenuta con concia ai sali di cromo e colorata in botte con aniline. Le pelli sono lavorate e trattate nel rispetto dell'ambiente con prodotti atossici in modo da mantenere le caratteristiche naturali; sono quindi più frequenti i segni distintivi della vita dell'animale rispetto alle pelli corrette. Ciò garantisce ed esalta la naturale bellezza. Sono idrorepellenti nella giusta misura, tenendo conto delle esigenze di permeabilità e traspirazione che sono attributi esclusivi della vera pelle. Le irregolarità della superficie quali rughe, smagliature, venature, differenze di grana o colore, non sono difetti, ma testimonianza di una vita animale naturale, impreziosiscono così ogni pezzo rendendolo unico e diverso da qualsiasi altro. Per tali motivi non è possibile garantire la medesima tonalità di colore fra una partita e l'altra.

The quality of the leather comes from a careful selection of raw hides from Europe or outside Europe, thickness 0,9-1,0 mm, obtained with chrome tanning and dyed in the tub with aniline. The hides are worked and treated with respect for the environment using non-toxic products in order to maintain their natural characteristics and therefore the distinctive signs of the life of the animal appear with greater frequency than in corrected hides. This guarantees and enhances their natural beauty. The leather produced is water-repellent to the right degree while bearing in mind the needs for permeability and breathability that only genuine leather provides. Irregularities in the surface such as wrinkles, stretch marks, veining, and differences in grain or shades of colour are not defects but testify to the natural life of the animal and render each piece unique and unlike any other. For these reasons, we cannot guarantee the same shades of colour in one batch and another.



860 Nero

859 Antracite

827 Grigio

810 Bianco

825 Testa di moro

824 Marrone



811 Crema

819 Cuoio

844 Granata

842 Rosso

839 Minio

838 Arancio



836 Girasole

857 Blu notte

856 Blu zaffiro

852 Blu

851 Turchese

833 Verde Inglese



830 Verde bosco

59

# pelle fiore

COMPOSITION  
Genuine Leather

FASTNESS TO LIGHT  
(UNI EN ISO 105-B02) 6

FASTNESS TO RUBBING  
DRY (UNI EN ISO 11640)  
1000 rubs val. 4 Grey Scale  
WET (UNI EN ISO 11640)  
250 rubs val. 4 Grey Scale

TEAR RESISTANCE  
(UNI EN ISO 3377-1) >20N

## PX



2052 Gesso bianco

La qualità della pelle è data da un'accurata selezione dei grezzi di origine Europea, spessore 1,2-1,4 mm, ottenuta con concia ai sali di cromo e colorata in botte con aniline. Le pelli sono lavorate e trattate nel rispetto dell'ambiente con prodotti atossici in modo da mantenerne le caratteristiche naturali; sono quindi più frequenti i segni distintivi della vita dell'animale rispetto alle pelli corrette. Ciò garantisce ed esalta la naturale bellezza. Sono idrorepellenti nella giusta misura, tenendo conto delle esigenze di permeabilità e traspirazione che sono attributi esclusivi della vera pelle. Le irregolarità della superficie quali rughe, smagliature, venature, differenze di grana o colore, non sono difetti, ma testimonianza di una vita animale naturale, impreziosiscono così ogni pezzo rendendolo unico e diverso da qualsiasi altro. Per tali motivi non è possibile garantire la medesima tonalità di colore fra una partita e l'altra.

60

The quality of the leather comes from a careful selection of raw hides from Europe or outside Europe, thickness 1,2-1,4 mm, obtained with chrome tanning and dyed in the tub with aniline. The hides are worked and treated with respect for the environment using non-toxic products in order to maintain their natural characteristics and therefore the distinctive signs of the life of the animal appear with greater frequency than in corrected hides. This guarantees and enhances their natural beauty. The leather produced is water-repellent to the right degree while bearing in mind the needs for permeability and breathability that only genuine leather provides. Irregularities in the surface such as wrinkles, stretch marks, veining, and differences in grain or shades of colour are not defects but testify to the natural life of the animal and render each piece unique and unlike any other. For these reasons, we cannot guarantee the same shades of colour in one batch and another.



2024 Crema    2194 Panna    2018 Fieno    2044 Senape    2100 Pelle    2114 Ambra



2070 Arancio    2202 Aragosta    2112 Minio    2108 Castagno    2082 Scarlatto    2120 Bordeaux



2032 Granata    2088 Rosso cupo    2214 Kaki    2064 Kaki scuro    2066 Terra di Siena    2212 Ecrù



2068 Tabacco    2060 Mattone    2126 Marrone    2252 Vinaccia    2110 Prugna    2136 Té verde



2056 Verde acqua    2036 Verde acqua scuro    2046 Verde bosco    2258 Grigio caldo scuro    2076 Grigio piombo    2132 Celadon



2130 Menta chiaro    2140 Lilla    2250 Malva chiaro    2256 Tortora    2092 Grigio    2074 Ardesia



2102 Malva    2240 Blu di Prussia    2008 Blu    2128 Sabbia    2072 Grigio caldo    2002 Nero



I colori pubblicati sono puramente indicativi. Per una riproduzione reale dei colori e finiture, vogliate contattarci per ottenere campioni di prodotti.

Published colours are for guidance only. For a true representation of colours and finish, please contact us for products samples.



Istituito nel 1992, il marchio comunitario di qualità ecologica o Ecolabel, il cui logo è rappresentato da un fiore, è uno speciale sistema di certificazione creato per aiutare i consumatori europei a scegliere prodotti e servizi più ecologici e più rispettosi dell'ambiente.

Established in 1992, the EU Eco-label "Flower" is a unique certification scheme aimed to help European consumers distinguish greener, more environmentally friendly, products and services.



DENOMINAZIONE D'ORIGINE ITALIANA DELLE PELLI  
ITALIAN ORIGIN DENOMINATION FOR LEATHERS



BILANCIO AMBIENTALE DI PRODOTTO  
ENVIRONMENTAL PRODUCT BALANCE



GRUPPO  
DANI



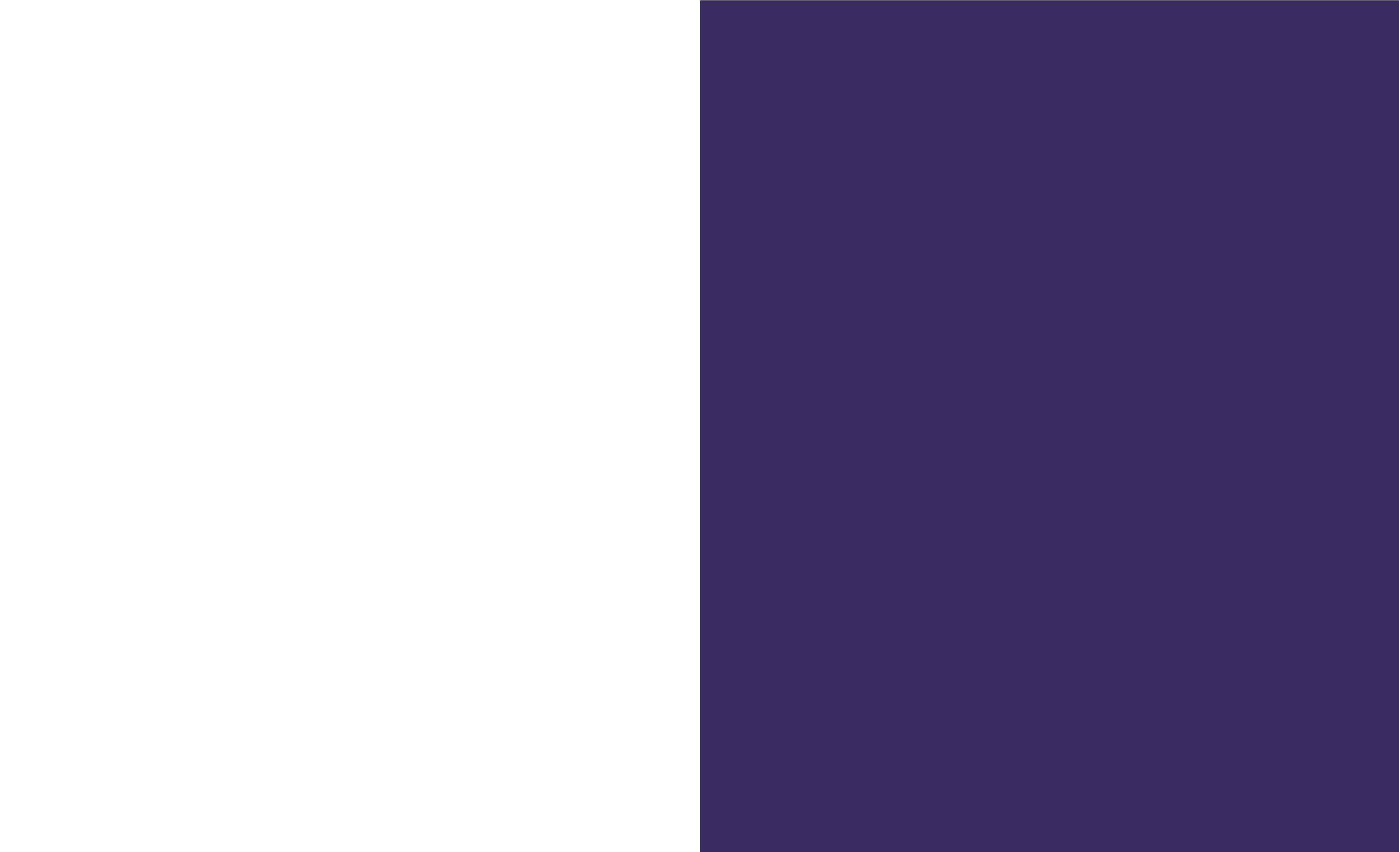



emmegi®